



SOTNAS

B A R B E C U E S

CONTACTS

+351 937 153 052

+351 253 331 277

geral@jardimqacontece.pt

www.sotnas.pt





Our story

GARDEN LIVING

PT: Bem-vindo à SOTNAS: o seu principal destino para soluções de qualidade para churrasqueiras e lareiras de exterior!

Na SOTNAS, somos apaixonados por criar os melhores produtos para churrasco e lareiras que melhoram o seu espaço exterior. Com um compromisso com a qualidade artesanal e uma dedicação inabalável à satisfação do cliente, somos reconhecidos como um nome confiável no setor.

Fundada com a visão de elevar a arte da culinária ao ar livre, a SOTNAS tem estado na vanguarda da inovação na fabricação de churrasqueiras e lareiras. O que começou como uma humilde oficina evoluiu para uma marca global, sinônimo de qualidade, durabilidade e prazer.

EN: Welcome to SOTNAS: Your Premier Destination for Quality Barbecue and Fireplace Solutions!

At SOTNAS, we are passionate about crafting the finest barbecue and fireplace products that enhance your outdoor living space. With a commitment to quality craftsmanship and an unwavering dedication to customer satisfaction, we have established ourselves as a trusted name in the industry, serving customers worldwide.

Founded with a vision to elevate the art of outdoor cooking, SOTNAS has been at the forefront of innovation in barbecue and fireplace manufacturing. What started as a humble workshop has evolved into a global brand synonymous with quality, durability, and enjoyment.



Quality Craftsmanship

PT: Cada produto da SOTNAS é meticulosamente projetado e fabricado utilizando materiais de mais alta qualidade e as mais recentes técnicas de fabricação. Desde churrasqueiras premium até aos designs elegantes das lareiras, priorizamos a excelência em cada detalhe para garantir que os nossos clientes recebem produtos que superem as suas expectativas.

EN: Every SOTNAS product is meticulously designed and crafted using the highest quality materials and the latest manufacturing techniques. From premium barbecues to elegant fireplaces designs, we prioritize excellence in every detail to ensure our customers receive products that exceed their expectations.

Global Reach

PT: Com uma forte presença em mercados de todo o mundo, a SOTNAS traz a alegria da cozinha ao ar livre e do aquecimento exterior a clientes em todo o mundo. Quer esteja a grelhar no seu jardim ou a aconchegar-se junto à lareira, os produtos da SOTNAS são concebidos para melhorar cada momento.

Na SOTNAS, a satisfação do cliente é a nossa principal prioridade. Esforçamo-nos para oferecer um serviço excepcional em todas as etapas da sua viagem connosco, desde explorar o nosso catálogo até desfrutar de sua nova churrasqueira ou lareira. A nossa equipa experiente está sempre pronta para ajudá-lo a encontrar a solução perfeita para as suas necessidades.

EN: With a strong presence in markets around the globe, SOTNAS brings the joy of outdoor cooking and indoor warmth to customers worldwide. Whether you're grilling in your backyard or cozying up by the fireplace in your garden, SOTNAS products are designed to enhance every moment.

At SOTNAS, customer satisfaction is our top priority. We strive to provide exceptional service at every stage of your journey with us, from browsing our catalog to enjoying your new barbecue or fireplace. Our knowledgeable team is always ready to assist you in finding the perfect solution for your needs.



Sotnas Family

PT: Experimente a diferença que o artesanato de qualidade e o design superior podem fazer nos seus espaços exteriores. Descubra a alegria de cozinhar com as churrasqueiras da SOTNAS e crie momentos inesquecíveis à volta da sua lareira. Junte-se à família SOTNAS hoje e eleve seu estilo de vida com os nossos produtos premium.

Obrigado por escolher a SOTNAS – onde a qualidade encontra o prazer e cada momento se torna extraordinário.

EN: Experience the difference that quality craftsmanship and superior design can make in your outdoor space. Discover the joy of cooking with SOTNAS grills and creating unforgettable moments around your fireplace. Join the SOTNAS family today and elevate your lifestyle with our premium products.

Thank you for choosing SOTNAS – where quality meets enjoyment, and every moment becomes extraordinary.

DISCOVER OUR PRODUCTS VIRTUALLY



EN: This innovative communication tool is an immersive and interactive experience. It allows our customers to choose the product more precisely and appropriately. Thanks to hyper realistic images with a 1:1 scale has never been easier to choose your ideal barbecue or fireplace.

You can find more information on how to use this function on our website.

PT: Esta ferramenta de comunicação inovadora é uma experiência interativa e imersiva. Permite que nossos clientes escolham o produto de forma mais precisa e adequada. Graças às imagens hiper-realistas com escala 1:1, nunca foi tão fácil escolher a sua churrasqueira ou lareira de exterior.

Pode encontrar mais informações sobre como usar esta função no nosso site.

ES: Esta innovadora herramienta de comunicación es una experiencia inmersiva e interactiva. Permite a nuestros clientes elegir el producto de forma más precisa y adecuada. Gracias a las imágenes hiperrealistas a escala 1:1 nunca ha sido tan fácil elegir tu barbacoa o chimenea ideal.

Puede encontrar más información sobre cómo utilizar esta función en nuestro sitio web.

FR: Cet outil de communication innovant est une expérience immersive et interactive. Cela permet à nos clients de choisir le produit de manière plus précise et appropriée. Grâce à des images hyper réalistes à l'échelle 1:1, il n'a jamais été aussi simple de choisir votre barbecue ou votre cheminée idéale.

Vous pouvez trouver plus d'informations sur la façon d'utiliser cette fonction sur notre site Web.



Index

Barbecue & Fireplace

Modern collection **12** Faro
16 Brasília
20 Maiorca
24 Barcelona

Tradicional collection **28** Roma
38 Barcelos

Rustic collection **50** Londres
60 Paris
64 Berlim

Hybrid collection **68** Mónaco
72 Luanda
76 Benguela
82 Ibiza

Fireplace collection **86** São Paulo
90 Sydney

Others **94** Grills & Accessories
102 Accessories
106 Gallery





T E X T U R E O V E R V I E W



Faro

Collection

Our Faro collection focuses mainly on modernizing the design while maintaining the structure and quality of the materials used. With advanced refractory cement technology, its resistance is extremely high. This category uses a modular shape that allows you to add and create a barbecue to suit your needs.

Faro Collection

Ref.800
Charcoal & Firewood
Barbecue

 80 x 55 x 217h cm

 60 x 38 cm | Ref.500

 Packed in euro palet
120 x 80 x 150h cm

 Net weight: 600 Kg
Total weight: 615 Kg



Ref.802
Charcoal & Firewood
Barbecue

 80 x 55 x 88h cm

 Packed in euro palet
60 x 40 x 50h cm

 Net weight: 250 Kg
Total weight: 260 Kg



Ref.801
Charcoal & Firewood
Barbecue

 80 x 55 x 88h cm

 Packed in euro palet
60 x 40 x 50h cm

 Net weight: 250 Kg
Total weight: 260 Kg

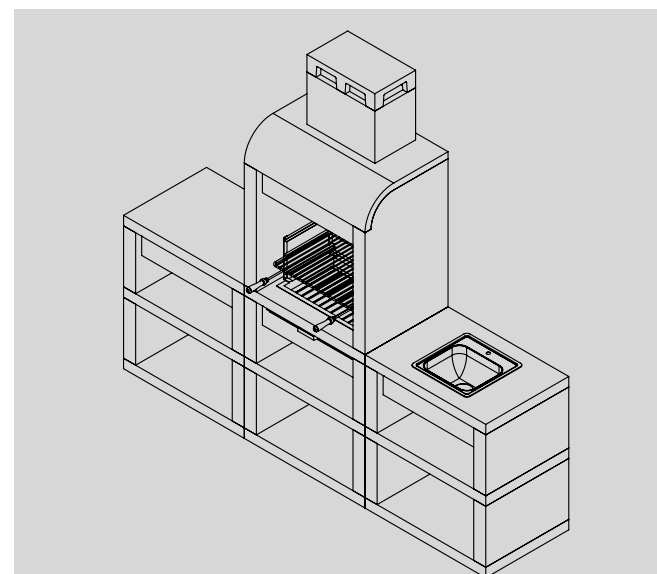

Ref.803
Charcoal & Firewood
Barbecue

 80 x 55 x 88h cm

 Packed in euro palet
60 x 40 x 50h cm

 Net weight: 250 Kg
Total weight: 260 Kg



Ref.804
Charcoal & Firewood
Barbecue

 119 x 55 x 88h cm

 Packed in euro palet
120 x 80 x 50h cm

 Net weight: 300 Kg
Total weight: 315 Kg



Brasília

Collection

Our Brasília collection allows us to combine our modern design with a more competitive price. Maintaining its high resistance and quality. This collection is also modular.



Brasília Collection

Ref.810

Charcoal & Firewood
Barbecue



80 x 55 x 206h cm



60 x 38 cm | Ref.700



Packed in euro palet
120 x 80 x 150h cm



Net weight: 500 Kg
Total weight: 515 Kg



Ref.812

Charcoal & Firewood
Barbecue



80 x 55 x 88h cm



Packed in euro palet
60 x 40 x 50h cm



Net weight: 180 Kg
Total weight: 190 Kg



Ref.811

Charcoal & Firewood
Barbecue



80 x 55 x 88h cm



Packed in euro palet
60 x 40 x 50h cm



Net weight: 180 Kg
Total weight: 190 Kg

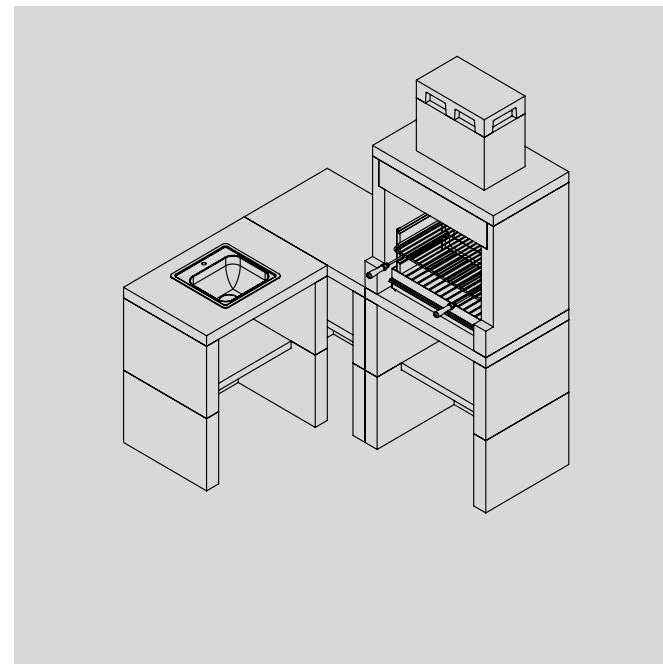

Ref.813

Charcoal & Firewood
Barbecue



80 x 55 x 88h cm



Packed in euro palet
60 x 40 x 50h cm



Net weight: 180 Kg
Total weight: 190 Kg



Ref.814

Charcoal & Firewood
Barbecue



119 x 55 x 88h cm



Packed in euro palet
120 x 80 x 50h cm



Net weight: 250 Kg
Total weight: 265 Kg





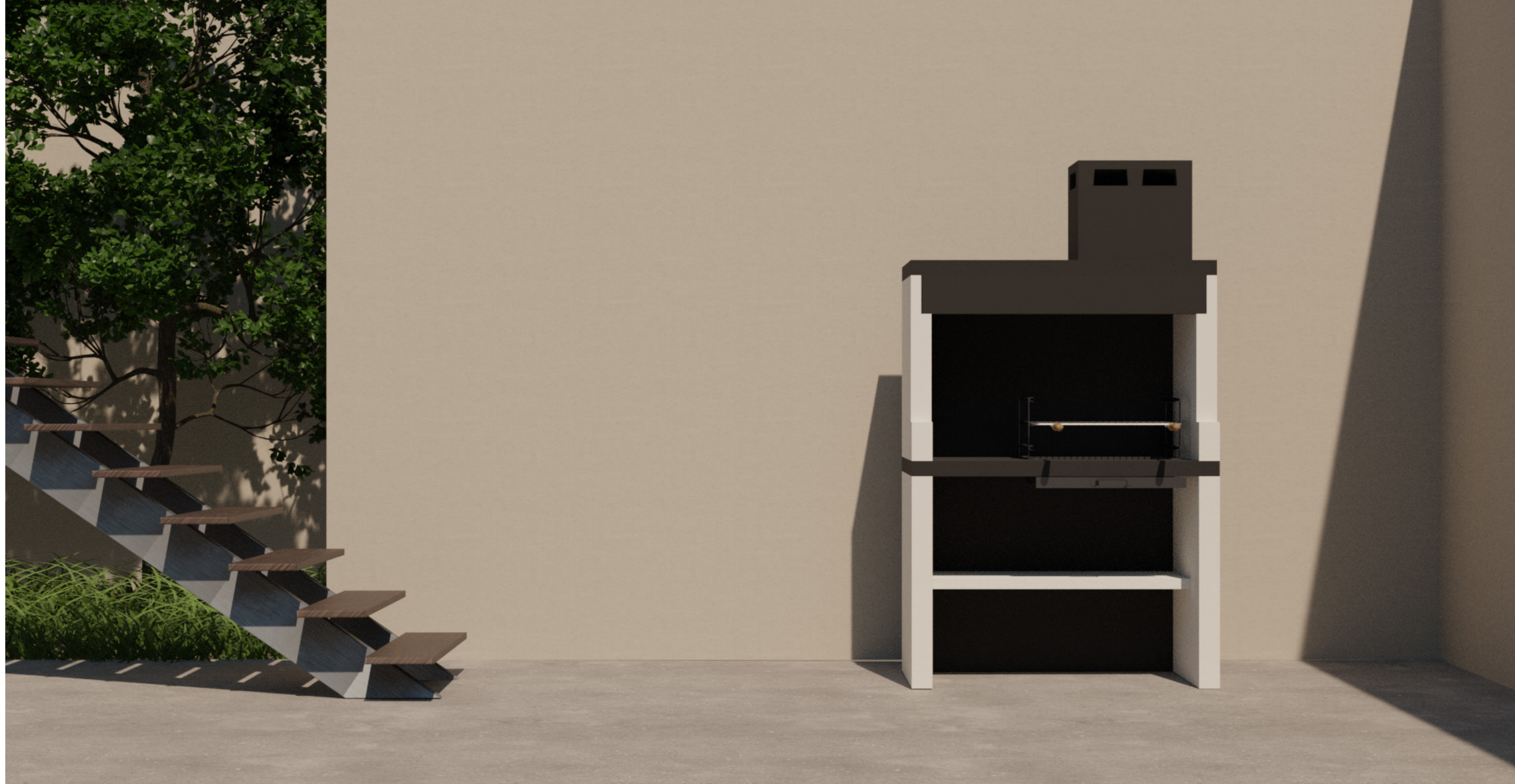

Maiorca Collection

The Maiorca collection has the same modern approach as the Faro and Brasília, but with an innovation. Its larger structure allows our customers to make more complete use of the space next to the grill.





Maiorca Collection

Ref.830
Charcoal & Firewood
Barbecue

-  119 x 55 x 206h cm
-  60 x 38 cm | Ref.500
-  60 x 38 cm | Ref.700
-  Packed in euro palet
120 x 80 x 150h cm
-  Net weight: 600 Kg
Total weight: 615 Kg



Ref.831
Charcoal & Firewood
Barbecue

-  80 x 55 x 88h cm
-  Packed in euro palet
60 x 40 x 50h cm
-  Net weight: 180 Kg
Total weight: 190 Kg





Ref.833
Charcoal & Firewood
Barbecue

-  80 x 55 x 88h cm
-  Packed in euro palet
60 x 40 x 50h cm
-  Net weight: 180 Kg
Total weight: 190 Kg





Ref.832
Charcoal & Firewood
Barbecue

-  80 x 55 x 88h cm
-  Packed in euro palet
60 x 40 x 50h cm
-  Net weight: 180 Kg
Total weight: 190 Kg



Ref.834
Charcoal & Firewood
Barbecue

-  119 x 55 x 88h cm
-  Packed in euro palet
120 x 80 x 50h cm
-  Net weight: 250 Kg
Total weight: 265 Kg



Barcelona

Collection

The Barcelona collection revolutionizes the market with its characteristics. These models have a modern design with an extremely detailed texture, it is a very complete collection that allows the customer to choose this barbecue with different accessories. Available in two colors, the Barcelona collection stands out for its quality, but above all its modernism.





Barcelona Collection





Ref.430

Charcoal & Firewood
Barbecue

 80 x 55 x 218h cm

 60 x 38 cm | Ref.500

 Packed in euro palet
120 x 80 x 150h cm

 Net weight: 600 Kg
Total weight: 615 Kg





Ref.431

Charcoal & Firewood
Barbecue

 118 x 55 x 218h cm

 60 x 38 cm | Ref.500

 Packed in euro palet
120 x 80 x 150h cm

 Net weight: 600 Kg
Total weight: 615 Kg

Ref.433

Charcoal & Firewood
Barbecue

 80 x 55 x 86h cm

 Packed in euro palet
60 x 40 x 50h cm

 Net weight: 250 Kg
Total weight: 260 Kg



Ref.432

Charcoal & Firewood
Barbecue

 80 x 55 x 86h cm

 Packed in euro palet
60 x 40 x 50h cm

 Net weight: 250 Kg
Total weight: 260 Kg



Ref.434

Charcoal & Firewood
Barbecue

 80 x 55 x 86h cm

 Packed in euro palet
60 x 40 x 50h cm

 Net weight: 250 Kg
Total weight: 260 Kg



Roma Collection

The Roma category is one of our oldest categories, however this category continues to be revolutionary in the barbecue market. In this category we can find our barbecues accompanied by an oven with the best finishes. It is without a doubt our most complete category and will always be a classic.





Roma Collection



Ref.102
Charcoal & Firewood
Barbecue

 268 x 96 x 236h cm

 60 x 38 cm | Ref.500

 Packed in 3 euro palets
120 x 80 x 150h cm

 Net weight: 1305 Kg
Total weight: 1350 Kg

Ref.100
Charcoal & Firewood
Barbecue

 256 x 96 x 236h cm

 60 x 38 cm | Ref.500

 Packed in 3 euro palets
120 x 80 x 150h cm

 Net weight: 1305 Kg
Total weight: 1350 Kg

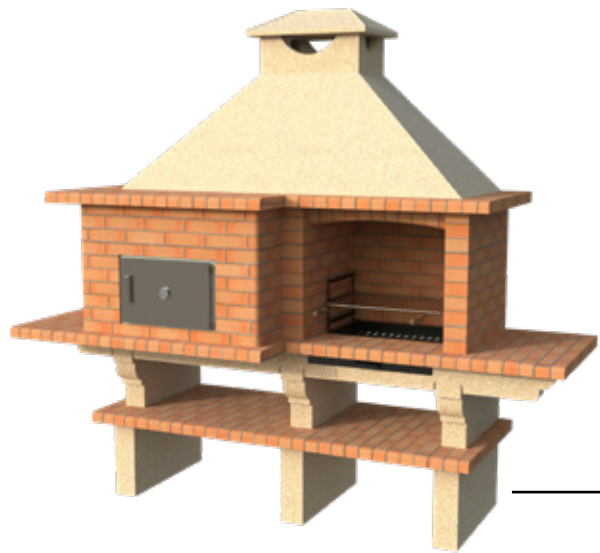

Ref.101
Charcoal & Firewood
Barbecue

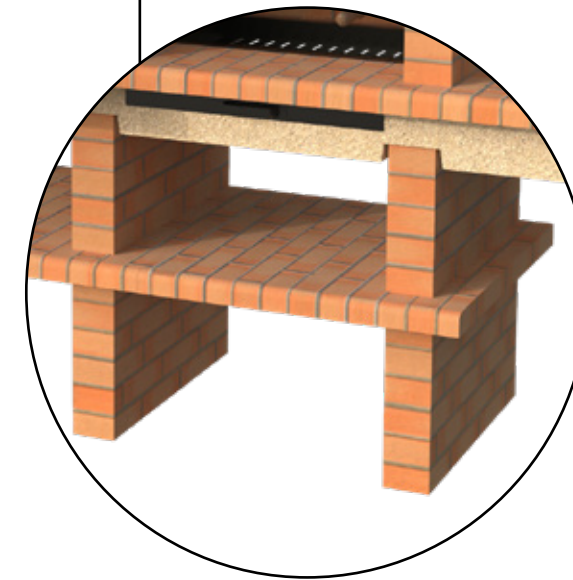
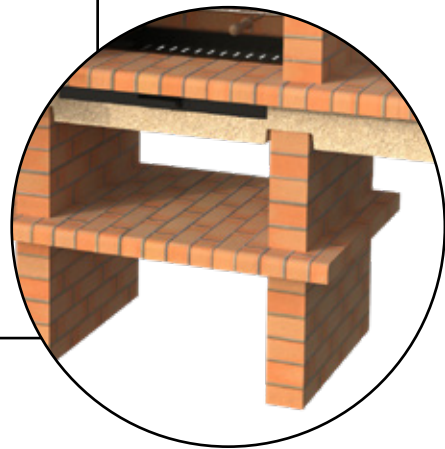



Ref.103
Charcoal & Firewood
Barbecue







Ref.102-1

Charcoal & Firewood
Barbecue

 304 x 96 x 236h cm
 60 x 38 cm | Ref.500

 Packed in 3 euro palets
120 x 80 x 150h cm

 Net weight: 1605 Kg
Total weight: 1650 Kg

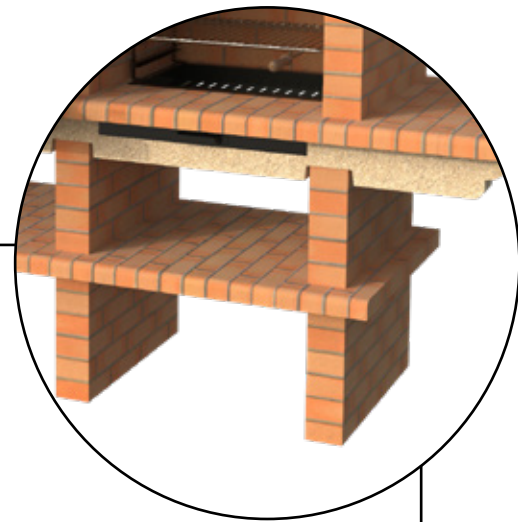

Ref.103-1

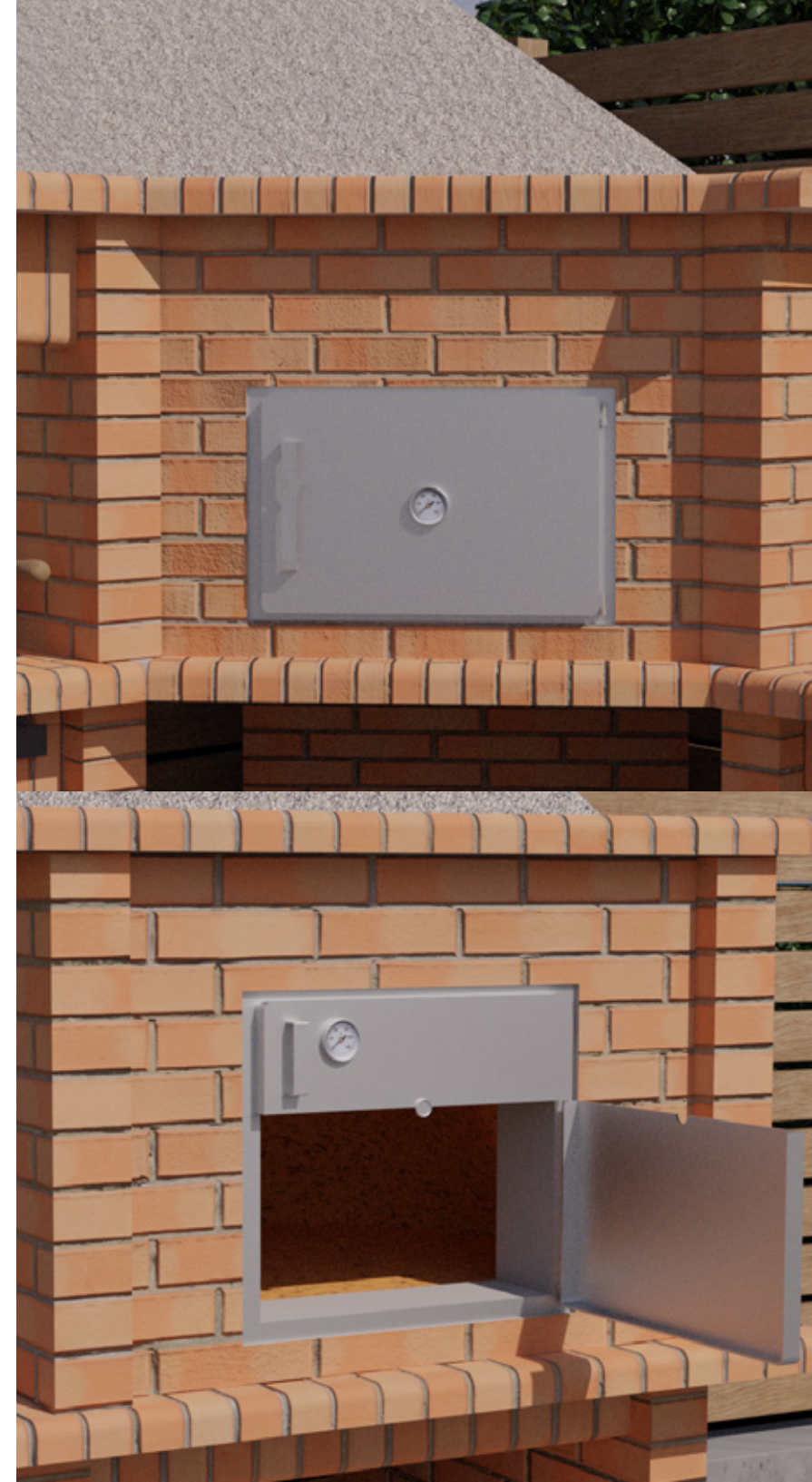

Charcoal & Firewood
Barbecue





BIGGER OVEN

Ref.130

Charcoal & Firewood
Barbecue

 300 x 108 x 247h cm
 69 x 48 cm | Ref.570

 Packed in 3 euro palets
120 x 80 x 150h cm

 Net weight: 2055 Kg
Total weight: 2100 Kg

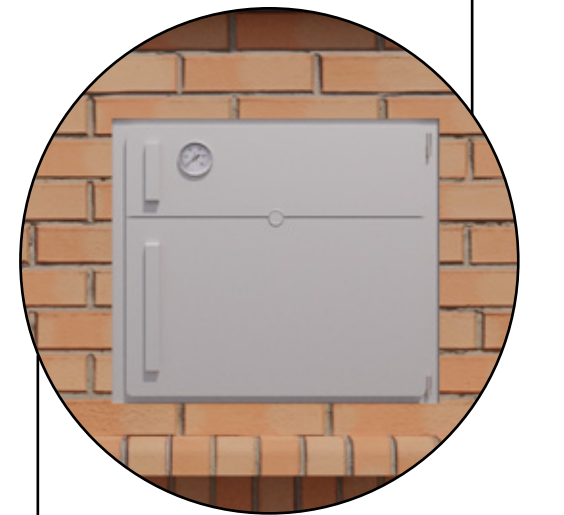



Split door option for
all models



Ref.131

Charcoal & Firewood
Barbecue

 310 x 73 x 237h cm - BBQ side
224 x 73 x 237h cm - Oven side
 69 x 48 cm | Ref.570

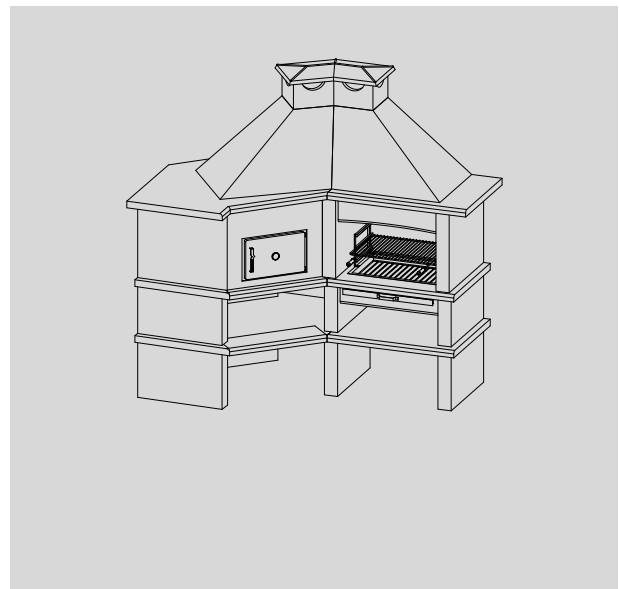
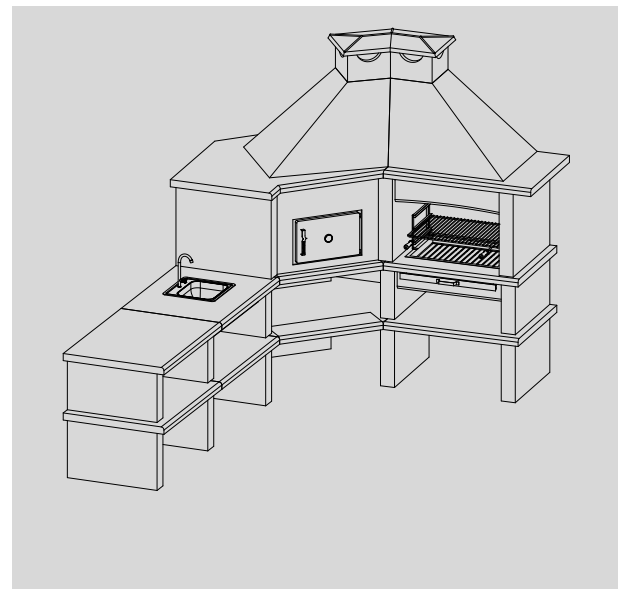
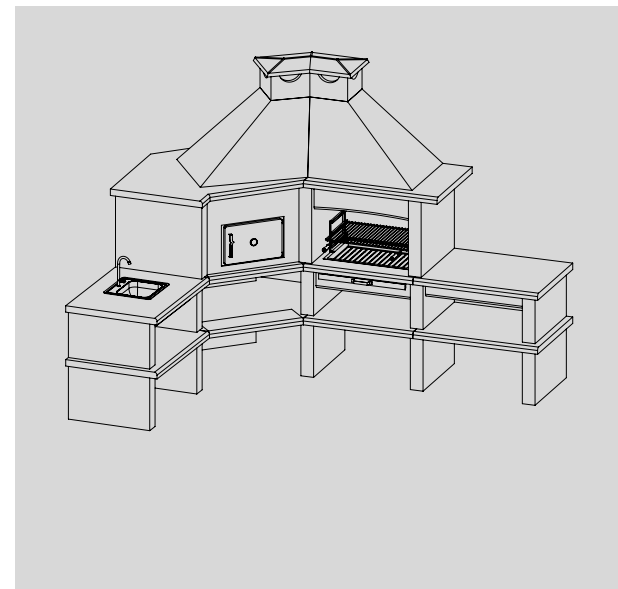

 Packed in 4 euro palets
120 x 80 x 150h cm

 Net weight: 3140 Kg
Total weight: 3200 Kg



Ref.132

Charcoal & Firewood
Barbecue

 266 x 96 x 238h cm
 78 x 48 cm | Ref.507

 Packed in 3 euro palets
120 x 80 x 150h cm

 Net weight: 1405 Kg
Total weight: 1450 Kg



BIGGER GRILL







Ref.104

Charcoal & Firewood
Barbecue

 144 x 96 x 233h cm

 Packed in 2 euro palets
120 x 80 x 150h cm

 Net weight: 890 Kg
Total weight: 900 Kg



Ref.133

Charcoal & Firewood
Barbecue

 127 x 108 x 243h cm

 Packed in 2 euro palets
120 x 80 x 150h cm

 Net weight: 1070 Kg
Total weight: 1100 Kg

BIGGER OVEN

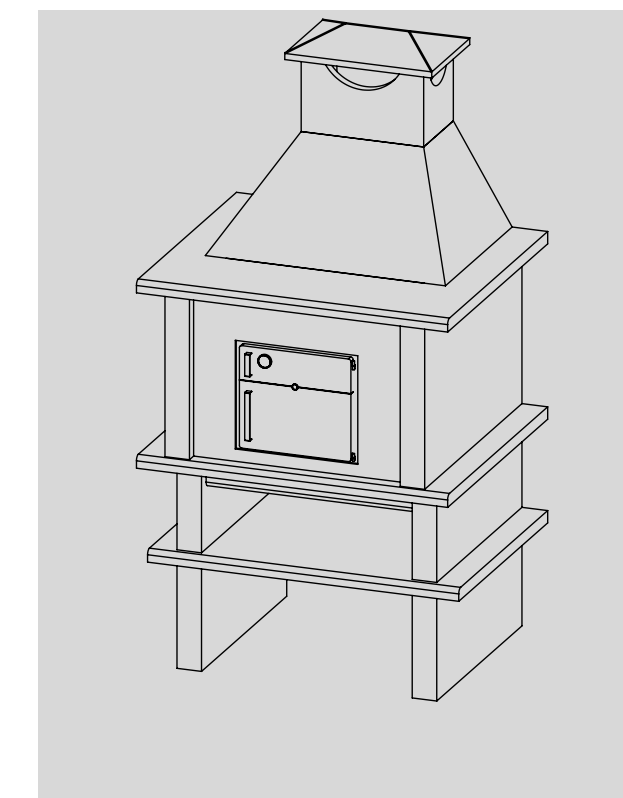

Barcelos

Collection

The Barcelos collection is where our entire brand began. Using refractory brick and cement prepared for high temperatures, all models guarantee the best quality on the market.

This traditional design continues to have a huge impact on the market worldwide.



Barcelos

Collection



Ref.105

Charcoal & Firewood
Barbecue



98 x 60 x 217h cm



60 x 38 cm | Ref.500



Packed in euro pallet
120 x 80 x 150h cm



Net weight: 500 Kg
Total weight: 515 Kg



Ref.106

Charcoal & Firewood
Barbecue



146 x 60 x 215h cm



60 x 38 cm | Ref.500



Packed in euro pallet
120 x 80 x 150h cm



Net weight: 600 Kg
Total weight: 615 Kg



Ref.107

Charcoal & Firewood
Barbecue



170 x 60 x 217h cm



60 x 38 cm | Ref.500



Packed in euro pallet
120 x 80 x 150h cm



Net weight: 700 Kg
Total weight: 715 Kg



Ref.108

Charcoal & Firewood
Barbecue



214 x 60 x 219h cm



60 x 38 cm | Ref.500



Packed in euro pallet
120 x 80 x 150h cm



Net weight: 750 Kg
Total weight: 765 Kg





Ref.109

Charcoal & Firewood
Barbecue

 146 x 60 x 225h cm

 60 x 38 cm | Ref.500

 Packed in euro palet
120 x 80 x 150h cm

 Net weight: 600 Kg
Total weight: 615 Kg





Ref.110

Charcoal & Firewood
Barbecue

 146 x 60 x 219h cm

 60 x 38 cm | Ref.500

 Packed in euro palet
120 x 80 x 150h cm

 Net weight: 560 Kg
Total weight: 575 Kg





Ref.110-1

Charcoal & Firewood
Barbecue

 98 x 60 x 217h cm

 60 x 38 cm | Ref.500

 Packed in euro palet
120 x 80 x 150h cm

 Net weight: 500 Kg
Total weight: 515 Kg





Ref.111

Charcoal & Firewood
Barbecue

 128 x 60 x 219h cm

 60 x 38 cm | Ref.500

 Packed in euro palet
120 x 80 x 150h cm

 Net weight: 580 Kg
Total weight: 595 Kg



Ref.112

Charcoal & Firewood
Barbecue

 98 x 60 x 218h cm

 60 x 38 cm | Ref.500

 Packed in euro palet
120 x 80 x 150h cm

 Net weight: 550 Kg
Total weight: 565 Kg



Ref.113
Charcoal & Firewood
Barbecue

 146 x 60 x 227h cm

 60 x 38 cm | Ref.500

 Packed in euro pallet
120 x 80 x 150h cm

 Net weight: 600 Kg
Total weight: 615 Kg



Ref.114
Charcoal & Firewood
Barbecue

 246 x 73 x 237h cm

 60 x 38 cm | Ref.500

 Packed in 2 euro palets
120 x 80 x 150h cm

 Net weight: 1100 Kg
Total weight: 1130 Kg



Ref.118
Charcoal & Firewood
Barbecue

 214 x 60 x 223h cm

 60 x 38 cm | Ref.500

 Packed in euro pallet
120 x 80 x 150h cm

 Net weight: 750 Kg
Total weight: 765 Kg

Ref.123

Charcoal & Firewood
Barbecue

 214 x 60 x 219h cm

 60 x 38 cm | Ref.500

 Packed in euro palet
120 x 80 x 150h cm

 Net weight: 760 Kg
Total weight: 775 Kg





Ref.124

Charcoal & Firewood
Barbecue

 115 x 73 x 231h cm

 78 x 48 cm | Ref.507

 Packed in euro palet
120 x 80 x 150h cm

 Net weight: 760 Kg
Total weight: 775 Kg

Ref.125

Charcoal & Firewood
Barbecue

 163 x 73 x 233h cm

 78 x 48 cm | Ref.507

 Packed in euro palet
120 x 80 x 150h cm

 Net weight: 775 Kg
Total weight: 790 Kg





Ref.126

Charcoal & Firewood
Barbecue

 169 x 60 x 225h cm

 60 x 38 cm | Ref.500

 Packed in euro palet
120 x 80 x 150h cm

 Net weight: 600 Kg
Total weight: 615 Kg

Ref.127

Charcoal & Firewood
Barbecue

 202 x 73 x 231h cm

 78 x 48 cm | Ref.507

 Packed in euro palet
120 x 80 x 150h cm

 Net weight: 1020 Kg
Total weight: 1050 Kg



48 | SOTNAS

Ref.128

Charcoal & Firewood
Barbecue

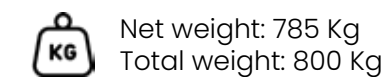
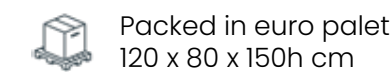
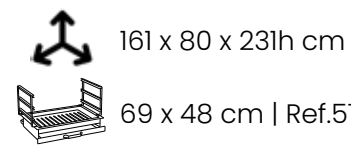

Ref.129

Charcoal & Firewood
Barbecue

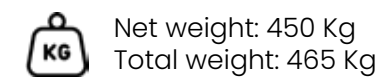
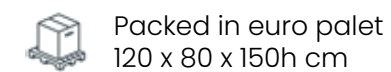
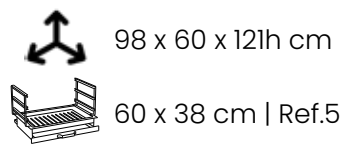

Ref.145

Charcoal & Firewood
Barbecue

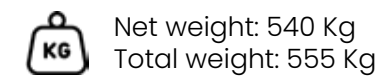
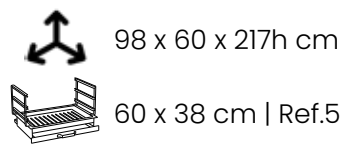

Ref.140

Charcoal & Firewood
Barbecue

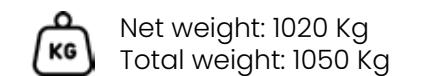
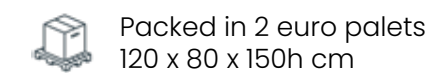
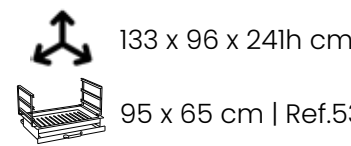



Londres

Collection

The Londres collection combines rustic and modern design. Its texture and high quality is a differentiating factor on the entire market. Available in two colors, this collection is one of the most revolutionary and searched from our costumers.

Londres Collection



Ref.460

Charcoal & Firewood
Barbecue

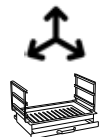

104 x 68 x 245h cm

69 x 48 cm | Ref.570



Packed in euro palet
120 x 80 x 150h cm



Net weight: 735 Kg
Total weight: 750 Kg



Ref.461

Charcoal & Firewood
Barbecue



186 x 68 x 245h cm

69 x 48 cm | Ref.570



Packed in euro palet
120 x 80 x 150h cm



Net weight: 935 Kg
Total weight: 950 Kg



Ref.462

Charcoal & Firewood
Barbecue



Ref.463

Charcoal & Firewood
Barbecue



206 x 98 x 245h cm

69 x 48 cm | Ref.570



Packed in 3 euro palets
120 x 80 x 150h cm



Net weight: 1855 Kg
Total weight: 1900 Kg



Ref.464

Charcoal & Firewood
Barbecue



286 x 98 x 245h cm

69 x 48 cm | Ref.570



Packed in 3 euro palets
120 x 80 x 150h cm



Net weight: 1955 Kg
Total weight: 2000 Kg





Ref.466

Charcoal & Firewood
Barbecue



104 x 68 x 90h cm



Packed in euro palet
60 x 40 x 50h cm



Net weight: 250 Kg
Total weight: 260 Kg



Ref.467

Charcoal & Firewood
Barbecue



104 x 68 x 90h cm



Packed in euro palet
60 x 40 x 50h cm



Net weight: 250 Kg
Total weight: 260 Kg



Ref.468

Charcoal & Firewood
Barbecue



104 x 68 x 90h cm



Packed in euro palet
60 x 40 x 50h cm



Net weight: 250 Kg
Total weight: 260 Kg



Ref.465

Charcoal & Firewood
Barbecue



109 x 98 x 245h cm



Packed in 2 euro palets
120 x 80 x 150h cm



Net weight: 900 Kg
Total weight: 930 Kg





Londres Collection



Ref.470

Charcoal & Firewood
Barbecue

 104 x 68 x 246h cm
 69 x 48 cm | Ref.570



 Packed in euro palet
120 x 80 x 150h cm

 Net weight: 750 Kg
Total weight: 765 Kg



Ref.471

Charcoal & Firewood
Barbecue

 184 x 68 x 246h cm
 69 x 48 cm | Ref.570

 Packed in euro palet
120 x 80 x 150h cm

 Net weight: 765 Kg
Total weight: 780 Kg





Ref.472

Charcoal & Firewood
Barbecue



Ref.473

Charcoal & Firewood
Barbecue

 206 x 98 x 246h cm
 69 x 48 cm | Ref.570



 Packed in 3 euro palets
120 x 80 x 150h cm

 Net weight: 1855 Kg
Total weight: 1900 Kg



Ref.474

Charcoal & Firewood
Barbecue

 286 x 98 x 246h cm
 69 x 48 cm | Ref.570

 Packed in 3 euro palets
120 x 80 x 150h cm

 Net weight: 1955 Kg
Total weight: 2000 Kg





Ref.476

Charcoal & Firewood
Barbecue



104 x 68 x 91h cm



Packed in euro palet
60 x 40 x 50h cm



Net weight: 250 Kg
Total weight: 260 Kg



Ref.477

Charcoal & Firewood
Barbecue



104 x 68 x 91h cm



Packed in euro palet
60 x 40 x 50h cm



Net weight: 250 Kg
Total weight: 260 Kg



Ref.478

Charcoal & Firewood
Barbecue



104 x 68 x 91h cm



Packed in euro palet
60 x 40 x 50h cm



Net weight: 250 Kg
Total weight: 260 Kg



Ref.475

Charcoal & Firewood
Barbecue



109 x 98 x 246h cm



Packed in 2 euro palets
120 x 80 x 150h cm



Net weight: 900 Kg
Total weight: 930 Kg



Paris Collection

The Paris collection arose from a bold idea of combining the traditional format that has always been a success with the more recent introduction of rustic material.

In this collection, we decided in collaboration with our partners to create a darker colour of brick that better suits the design.



Paris Collection



Ref.400

Charcoal & Firewood
Barbecue



96 x 60 x 221h cm



60 x 38 cm | Ref.500



Packed in euro palet
120 x 80 x 150h cm



Net weight: 550 Kg
Total weight: 565 Kg



Ref.401

Charcoal & Firewood
Barbecue



126 x 60 x 221h cm



60 x 38 cm | Ref.500



Packed in euro palet
120 x 80 x 150h cm



Net weight: 580 Kg
Total weight: 595 Kg



Ref.402

Charcoal & Firewood
Barbecue



144 x 60 x 219h cm



60 x 38 cm | Ref.500



Packed in euro palet
120 x 80 x 150h cm



Net weight: 600 Kg
Total weight: 615 Kg



Ref.403

Charcoal & Firewood
Barbecue



Ref.404

Charcoal & Firewood
Barbecue



211 x 60 x 219h cm



60 x 38 cm | Ref.500



Packed in euro palet
120 x 80 x 150h cm



Net weight: 760 Kg
Total weight: 775 Kg

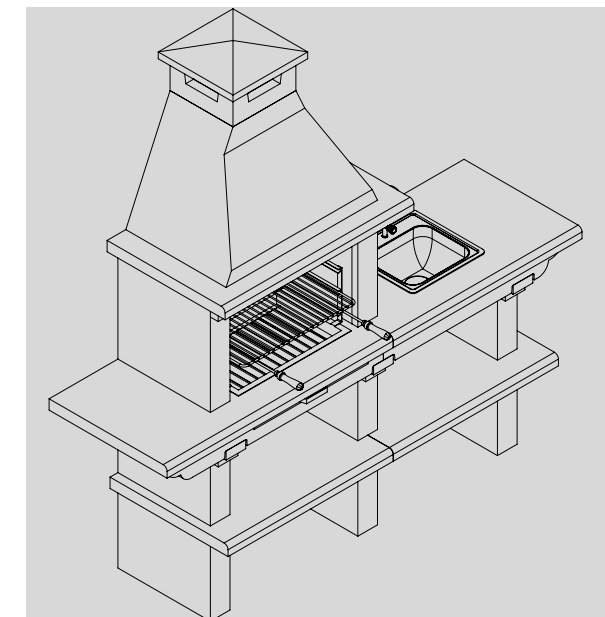

Berlim

Collection

The Berlim collection was initially nothing more than an aspect of the Paris collection with the difference of containing a larger grill.

These models had such high adherence that we decided to create a dedicated collection with a small change in the texture.

This became our most successful collection in the production line.





Berlim Collection



Ref.420
Charcoal & Firewood
Barbecue

 115 x 73 x 226h cm

 78 x 48 cm | Ref.507

 Packed in euro palet
120 x 80 x 150h cm

 Net weight: 700 Kg
Total weight: 715 Kg



Ref.421
Charcoal & Firewood
Barbecue

 163 x 73 x 234h cm

 78 x 48 cm | Ref.507

 Packed in euro palet
120 x 80 x 150h cm

 Net weight: 730 Kg
Total weight: 745 Kg



Ref.422
Charcoal & Firewood
Barbecue

 200 x 73 x 226h cm

 78 x 48 cm | Ref.507

 Packed in 2 euro palets
120 x 80 x 150h cm

 Net weight: 1020 Kg
Total weight: 1050 Kg



Mónaco

Collection

The Mónaco collection was inspired by combining the details of traditional brick with the modernism of cement. This collection is available in two colors and stands out for its details on the sides and feet.



Mónaco

Collection



Ref.490

Charcoal & Firewood
Barbecue



93 x 60 x 217h cm



60 x 38 cm | Ref.700



Packed in euro palet
120 x 80 x 150h cm



Net weight: 500 Kg
Total weight: 515 Kg



Ref.491

Charcoal & Firewood
Barbecue



127 x 60 x 217h cm



60 x 38 cm | Ref.700



Packed in euro palet
120 x 80 x 150h cm



Net weight: 550 Kg
Total weight: 565 Kg



Ref.493

Charcoal & Firewood
Barbecue

Ref.492

Charcoal & Firewood
Barbecue



168 x 60 x 217h cm



60 x 38 cm | Ref.700



Packed in euro palet
120 x 80 x 150h cm



Net weight: 700 Kg
Total weight: 715 Kg

Luanda Collection

The Luanda collection stands out for its cement details. Adding to these details our refractory brick and the ability to adapt different models, this collection is a success in several world markets.







Luanda Collection



Ref.900

Charcoal & Firewood
Barbecue





-  90 x 60 x 219h cm
-  60 x 38 cm | Ref.700 / Ref.513
-  Packed in euro palet
120 x 80 x 150h cm
-  Net weight: 500 Kg
Total weight: 515 Kg

 69 x 38 cm | 513
Compatible with all
Luanda models



Ref.901





Charcoal & Firewood
Barbecue

-  127 x 60 x 219h cm
-  60 x 38 cm | Ref.700 / Ref.513
-  Packed in euro palet
120 x 80 x 150h cm
-  Net weight: 550 Kg
Total weight: 565 Kg



Ref.902





Charcoal & Firewood
Barbecue

-  90 x 60 x 120h cm
-  60 x 38 cm | Ref.700 / Ref.513
-  Packed in euro palet
60 x 40 x 50h cm
-  Net weight: 300 Kg
Total weight: 310 Kg



Ref.903

Charcoal & Firewood
Barbecue

-  168 x 60 x 219h cm
-  60 x 38 cm | Ref.700 / Ref.513
-  Packed in euro palet
120 x 80 x 150h cm
-  Net weight: 700 Kg
Total weight: 715 Kg

Ref.904

Charcoal & Firewood
Barbecue



Benguela Collection

The Benguela collection arises from the need for a medium-priced product, but maintaining all the quality expectations of our products, this category uses the same materials but maintains a more simplistic and traditional design.



Benguela Collection



Ref.951

Charcoal & Firewood
Barbecue



90 x 60 x 121h cm



60 x 38 cm | Ref.700 / Ref.513



Packed in euro palet
60 x 40 x 50h cm



Net weight: 250 Kg
Total weight: 260 Kg



Ref.953

Charcoal & Firewood
Barbecue



168 x 60 x 217h cm



60 x 38 cm | Ref.700 / Ref.513



Packed in euro palet
120 x 80 x 150h cm



Net weight: 700 Kg
Total weight: 715 Kg

Ref.952

Charcoal & Firewood
Barbecue



Ref.954

Charcoal & Firewood
Barbecue



90 x 60 x 217h cm



60 x 38 cm | Ref.700 / Ref.513



Packed in euro palet
120 x 80 x 150h cm



Net weight: 500 Kg
Total weight: 515 Kg



69 x 38 cm | 513
Compatible with all
Benguela models

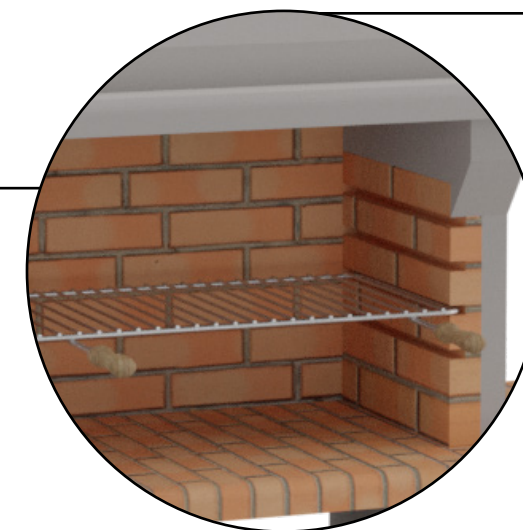

Ref.955

Charcoal & Firewood
Barbecue



127 x 60 x 217h cm



60 x 38 cm | Ref.700 / Ref.513



Packed in euro palet
120 x 80 x 150h cm



Net weight: 530 Kg
Total weight: 545 Kg



Ref.956

Charcoal & Firewood
Barbecue

-  241 x 60 x 217h cm
-  60 x 38 cm | Ref.700 / Ref.513
-  Packed in euro palet
120 x 80 x 150h cm
-  Net weight: 780 Kg
Total weight: 795 Kg





Ref.957
Charcoal & Firewood
Barbecue



Ref.958

Charcoal & Firewood
Barbecue



-  96 x 60 x 84h cm
-  Packed in euro palet
60 x 40 x 50h cm
-  Net weight: 150 Kg
Total weight: 160 Kg

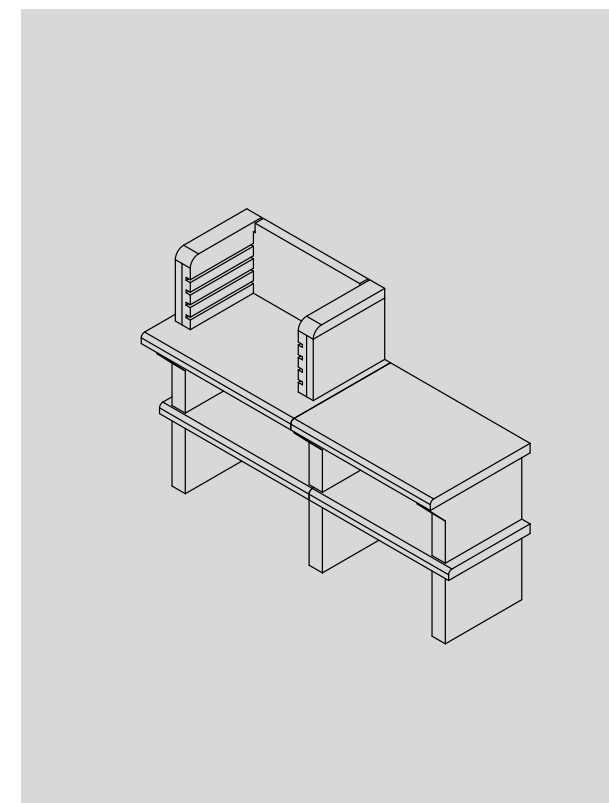
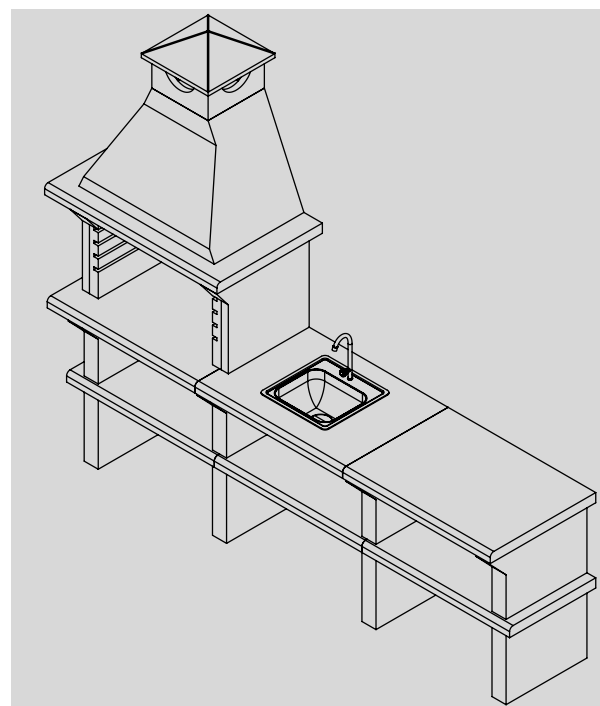
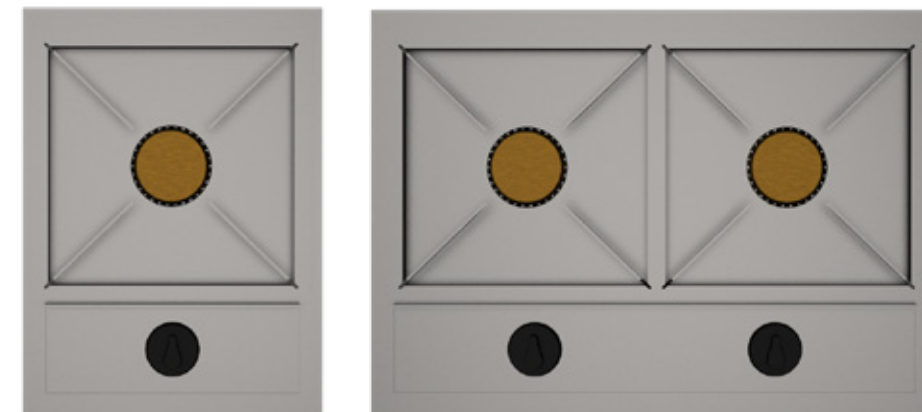

Ibiza

Collection

The Ibiza collection is a combination of the Luanda and Benguela collections, it emerged from a project carried out directly with one of our partners and has since become one of our brand's biggest successes. With a wide variety of high quality products this collection meets the needs of all customers.



Ibiza Collection



Ref.964

Charcoal & Firewood
Barbecue



90 x 60 x 219h cm



60 x 38 cm | Ref.700 / Ref.513



Packed in euro palet
120 x 80 x 150h cm



Net weight: 500 Kg
Total weight: 515 Kg



69 x 38 cm | 513
Compatible with all
Ibiza models
Except ref.967



Ref.965

Charcoal & Firewood
Barbecue



127 x 60 x 219h cm



60 x 38 cm | Ref.700 / Ref.513



Packed in euro palet
120 x 80 x 150h cm



Net weight: 530 Kg
Total weight: 545 Kg

Ref.967

Charcoal & Firewood
Barbecue



110 x 73 x 235h cm



80 x 46 cm | Ref.720



Packed in euro palet
120 x 80 x 150h cm



Net weight: 700 Kg
Total weight: 715 Kg



Ref.963

Charcoal & Firewood
Barbecue



168 x 60 x 219h cm



60 x 38 cm | Ref.700 / Ref.513



Packed in euro palet
120 x 80 x 150h cm



Net weight: 700 Kg
Total weight: 715 Kg



Ref.963-1

Charcoal & Firewood
Barbecue

São Paulo Collection

The São Paulo collection is a new and innovative approach to outdoor heating. This outdoor fireplace allows you to create a comfortable environment even outside your home. Available in two colors and with our rustic texture, this collection is a success for our brand.



São Paulo

Collection

Ref.310

Charcoal & Firewood
Barbecue



94 x 70 x 195h cm



Packed in euro palet
120 x 80 x 150h cm



Net weight: 550 Kg
Total weight: 565 Kg



Ref.311

Charcoal & Firewood
Barbecue



210 x 70 x 195h cm



Packed in euro palet
120 x 80 x 150h cm



Net weight: 750 Kg
Total weight: 765 Kg



Sydney

Collection

The Sydney collection is a category focused on providing a comforting environment around you, with its simplicity this collection is revolutionizing the market for small outdoor fireplaces. Available in three colors and with a smooth texture.



Sydney

Collection

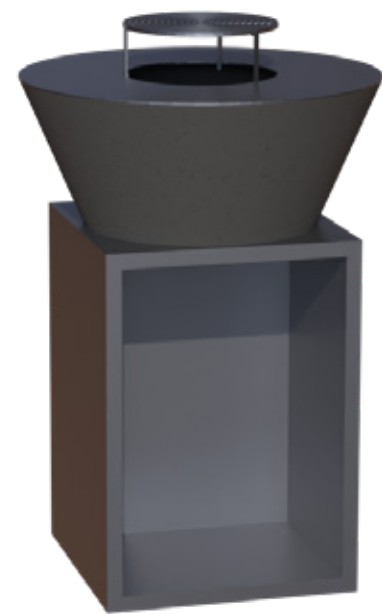

Ref.320

Charcoal & Firewood
Barbecue

Cone Cone base: Ø45 cm
Height: 29 cm
Plate: 70,5 cm
Plate hole: Ø30 cm
Plate height: 0,40 cm

Box Height: 70 cm
Width: 50 cm
Depth: 50 cm
Thickness: 3 cm



Packed in euro palet
120 x 80 x 150h cm



Net weight: 100 Kg
Total weight: 115 Kg





GRILLS & ACCESSORIES

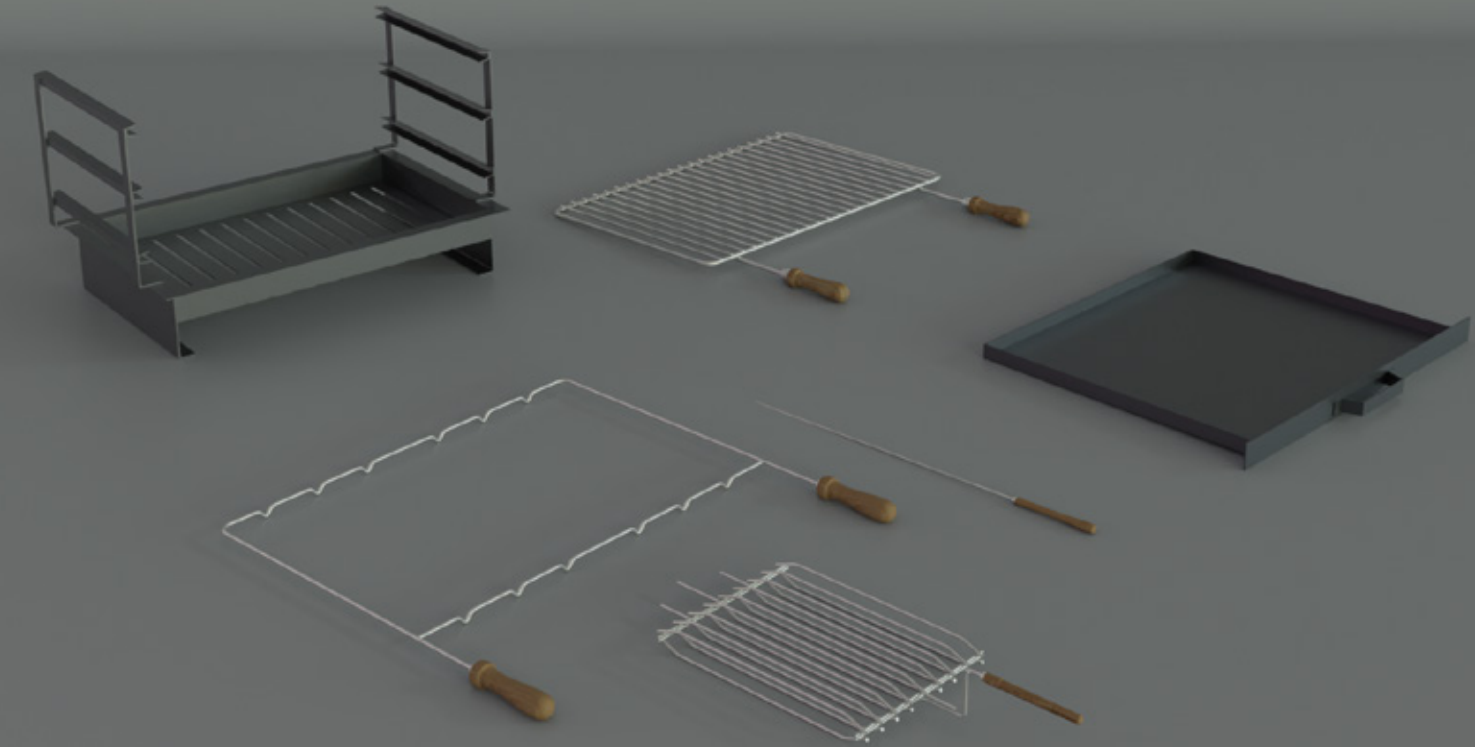



Complete grill - **60 x 38 cm**
 Ref.: **500** - Iron
 Ref.: **600** - Stainless steel



Ash drawer - **52 x 58 cm**
 Ref.: **525** - Iron
 Ref.: **625** - Stainless steel



Ash drawer - **52 x 46 cm**
 Ref.: **501** - Iron
 Ref.: **601** - Stainless steel

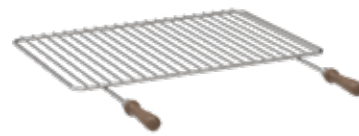

Hand grill - **58 x 38 cm**
 Ref.: **502** - Iron
 Ref.: **602** - Stainless steel



Complete grill - **69 x 48 cm**
 Ref.: **570** - Iron
 Ref.: **670** - Stainless steel



Ash drawer - **61 x 60 cm**
 Ref.: **571** - Iron
 Ref.: **671** - Stainless steel



Hand grill - **67 x 44 cm**
 Ref.: **572** - Iron
 Ref.: **672** - Stainless steel



Grill - **69 x 48 cm**
 Ref.: **573** - Iron
 Ref.: **673** - Stainless steel



Grill - **60 x 38 cm**
 Ref.: **503** - Iron
 Ref.: **603** - Stainless steel

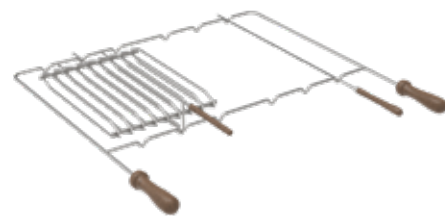

Full accessories grill - **58 x 38 cm**
 Ref.: **504** - Iron
 Ref.: **604** - Stainless steel



Universal grill - **25 x 35 cm**
 Ref.: **505** - Iron
 Ref.: **605** - Stainless steel



Skewer
 Ref.: **608** - Stainless steel

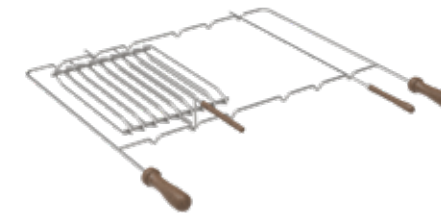

Full accessories grill - **63 x 44 cm**
 Ref.: **574** - Iron
 Ref.: **674** - Stainless steel



Universal grill - **25 x 41 cm**
 Ref.: **505** - Iron
 Ref.: **605** - Stainless steel



Skewer
 Ref.: **608** - Stainless steel

Compatible with ref.: 100; 101; 102; 103; 102/1; 103/1; 114; 108; 119; 118; 126; 123; 129; 110; 122; 106; 120; 109; 113; 111; 112; 110/1; 105; 107; 400; 401; 402; 403; 404; 430; 431; 436;

Compatible with ref.: 130; 131; 128; 470; 471; 472; 473; 474; 460; 461; 462; 463; 464;



Complete grill - **78 x 48 cm**
 Ref.: **507** - Iron
 Ref.: **611** - Stainless steel



Ash drawer - **71 x 58 cm**
 Ref.: **508** - Iron
 Ref.: **612** - Stainless steel



Hand grill - **76 x 44 cm**
 Ref.: **509** - Iron
 Ref.: **613** - Stainless steel



Grill - **78 x 48 cm**
 Ref.: **510** - Iron
 Ref.: **614** - Stainless steel



Complete grill - **60 x 38 cm**
 Ref.: **700** - Iron
 Ref.: **680** - Stainless steel



Ash drawer - **59 x 37 cm**
 Ref.: **711** - Iron
 Ref.: **682** - Stainless steel

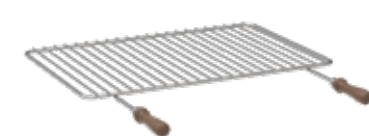

Hand grill - **58 x 38 cm**
 Ref.: **502** - Iron
 Ref.: **602** - Stainless steel

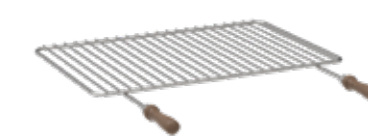

Hand grill - **69 x 38 cm**
 Ref.: **513** - Iron



Full grill
 Ref.: **545**
 Compatible with ref.: 145

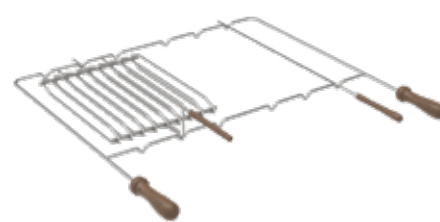

Full accessories grill - **76 x 38 cm**
 Ref.: **511** - Iron
 Ref.: **615** - Stainless steel



Universal grill - **25 x 41 cm**
 Ref.: **505** - Iron
 Ref.: **605** - Stainless steel



Skewer
 Ref.: **608** - Stainless steel



Full grill
 Ref.: **711** - Iron
 Ref.: **681** - Stainless steel

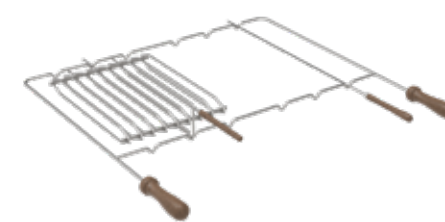

Full accessories grill - **58 x 38 cm**
 Ref.: **504** - Iron
 Ref.: **604** - Stainless steel

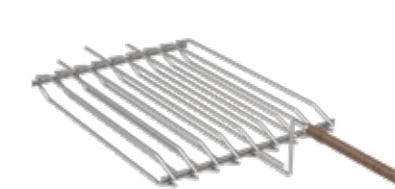

Universal grill - **25 x 35 cm**
 Ref.: **505** - Iron
 Ref.: **605** - Stainless steel



Skewer
 Ref.: **608** - Stainless steel

Compatible with ref.: 132; 124; 125; 127; 420; 421; 422;

Compatible with ref.: 490; 491; 492; 493; 900; 901; 902; 903; 904; 951; 952; 953; 954; 955; 956; 957; 963; 964; 965;



Complete grill - **95 x 65 cm**
Ref.: **530** - Iron



Ash drawer - **83 x 78 cm**
Ref.: **531** - Iron



Hand grill - **90 x 65 cm**
Ref.: **532** - Iron



Grill - **92 x 65 cm**
Ref.: **533** - Iron



Stove - **40 x 40 cm**
Ref.: **660** - Stainless steel

Compatible with ref.: 140;

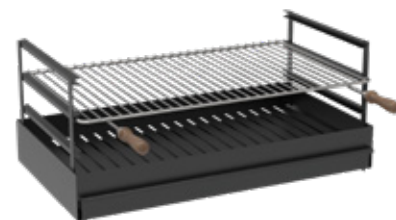

Complete grill - **80 x 46 cm**
Ref.: **720** - Iron



Ash drawer - **78 x 45 cm**
Ref.: **721** - Iron

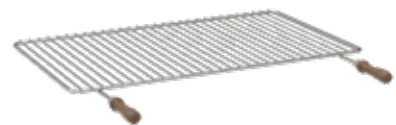

Universal grill - **78 x 46 cm**
Ref.: **722** - Iron

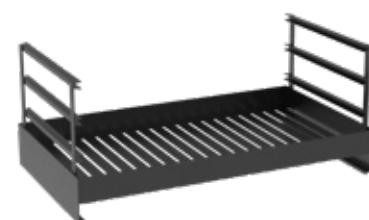

Complete grill - **80 x 46 cm**
Ref.: **723** - Iron



Stove - **60 x 40 cm**
Ref.: **661** - Stainless steel

Compatible with ref.: 967;



Spinning chimney cowl
Ref.: **014; 015**



Black spinning chimney cowl
Ref.: **014P; 015P**



ACCESSORIES

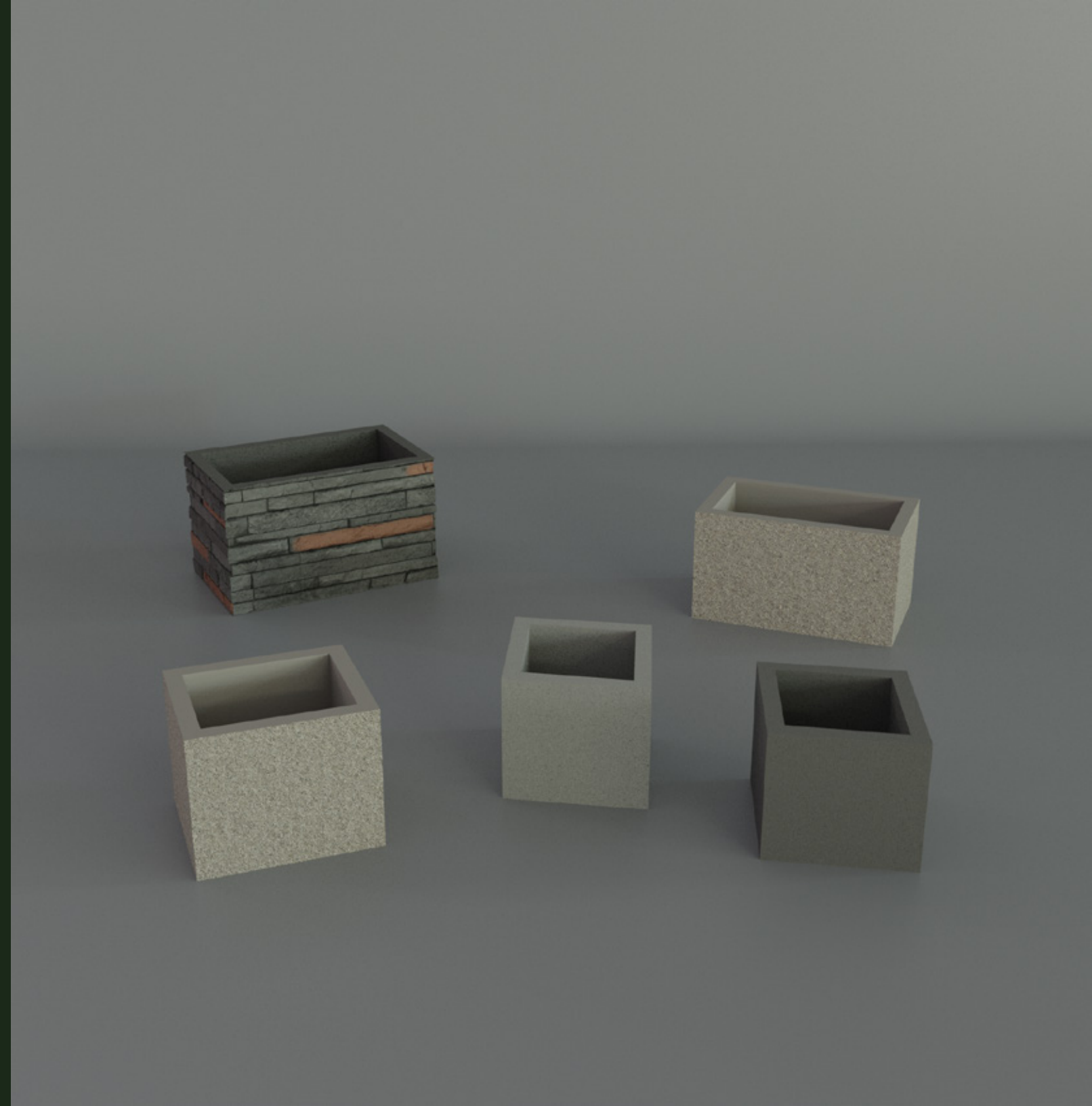

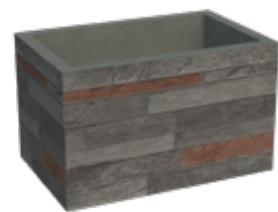

Ref.: **008**

Compatible with Londres collection
Height: 50 cm | Width: 32 cm
Depth: 42 cm

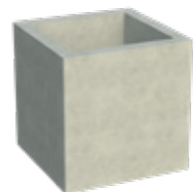

Ref.: **009**

Compatible with Luanda, Benguela, Ibiza collection
Height: 30 cm | Width: 30 cm
Depth: 30 cm



Ref.: **012**

Compatible with Berlim, Paris collection
Height: 30 cm | Width: 30 cm
Depth: 30 cm

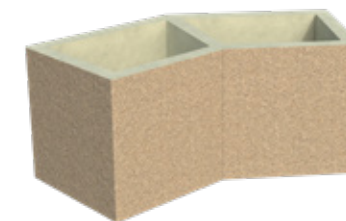

Ref.: **019**

Compatible with ref.: 131 Roma collection

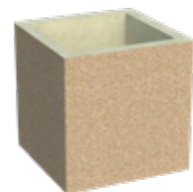

Ref.: **010**

Compatible with Barcelos collection
Height: 30 cm | Width: 30 cm
Depth: 30 cm

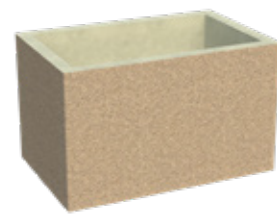

Ref.: **011**

Compatible with Roma collection
Height: 32 cm | Width: 50 cm
Depth: 32 cm



Ref.: **021**

Compatible with Londres collection

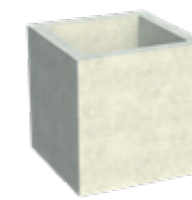

Ref.: **024**

Compatible with Monaco collection
Height: 30 cm | Width: 30 cm
Depth: 30 cm



Ref.: **025**

Compatible with Faro, Brasilia, Maiorca collection
Height: 45 cm | Width: 27 cm
Depth: 30 cm



GALLERY







Contacts

+351 937 153 052

+351 253 331 277

geral@jardimqacontece.pt

www.sotnas.pt

 @sotnas-barbecues

 @sotnasjqa

 @sotnas.barbecues

 @SOTNAS-Barbecues

 @Sotnas-Barbecues



